

Outline S

OUT 065 283 077A 8040 10 99 OP 40 TK

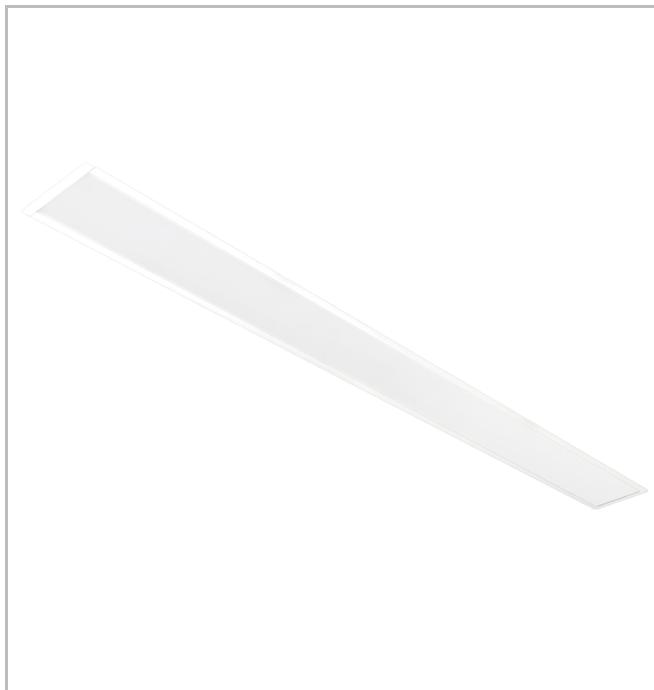

Recessed Linear Luminary



Luminaire Group	Linear
Mounting Type	Recessed
Luminary Color	RAL 9010 - RAL 9016
Housing	Aluminum extruded profile
Optics	Opal Diffuser
Electrical Protection Class	CLASS II
Operating Temperature	-20°C / +40°C
Luminous Flux	7107
Consumption Power	66
Luminaire Efficiency	2413 lm / 3526 lm / 6125 lm / 7107 lm
Color Rendering (CRI)	>80
Light Color Temperature (CCT)	2700K/3000K/4000K/6500K
Color Tolerance	< 3 SDCM
Driver Type	On/Off
Driver Brand	Tridonic
LED Brand	Samsung
Input Voltage / Frequency	220-240 V AC 50/60 Hz
Power Factor	>0.9
Surge	1kV
THD (AKIM)	>%20
LED life	>70.000 hours
Light Source	LED
Luminaire Efficiency	92,81 lm/W

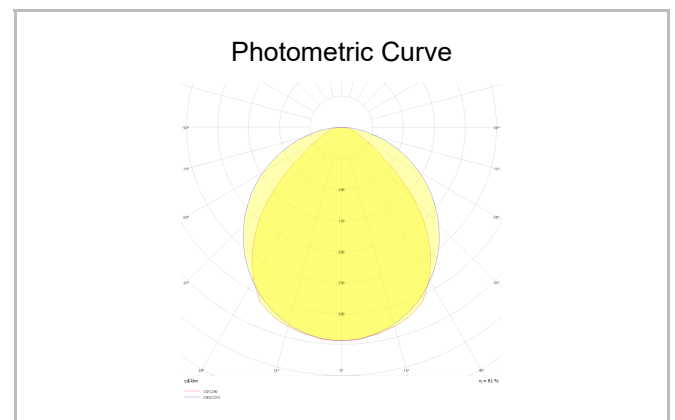
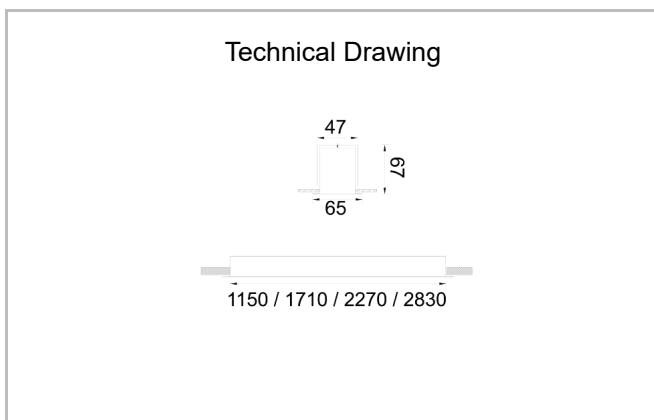

SKU	Product Code	Power (W)	Luminous Flux (LM)	CRI	CCT (K)	Optics	Dimensions (mm)
	OUT 065 283 077A 8040 10 99 OP 40 TK	66	7107	>80	4000	Opal / 120°	2830x65x67