

# Loopy

LPY 008 011 009B 8040 10 30 SD 20 00



Recessed Concept Ceiling Luminary



<b>Luminaire Group</b>	Concept Ceiling
<b>Mounting Type</b>	Recessed
<b>Luminaire Color</b>	RAL 9005 - RAL 9010 - RAL 9006
<b>Housing</b>	Aluminum DKP Sheet
<b>Optics</b>	Reflector
<b>Electrical Protection Class</b>	CLASS II
<b>Operating Temperature</b>	-20°C / +40°C
<b>Luminous Flux</b>	810
<b>Consumption Power</b>	9
<b>Luminaire Efficiency</b>	90 lm/W
<b>Color Rendering (CRI)</b>	>80
<b>Light Color Temperature (CCT)</b>	2700K/3000K/4000K/6500K
<b>Color Tolerance</b>	< 3 SDCM
<b>Driver Type</b>	On/Off
<b>Driver Brand</b>	Tridonic
<b>LED Brand</b>	Samsung
<b>Input Voltage / Frequency</b>	220-240 V AC 50/60 Hz
<b>Power Factor</b>	>0.9
<b>Surge</b>	1kV
<b>THD (AKIM)</b>	>%20
<b>LED life</b>	>100.000 hours
<b>Option</b>	On-Off / Dali / 1-10V / With Emergency Kit

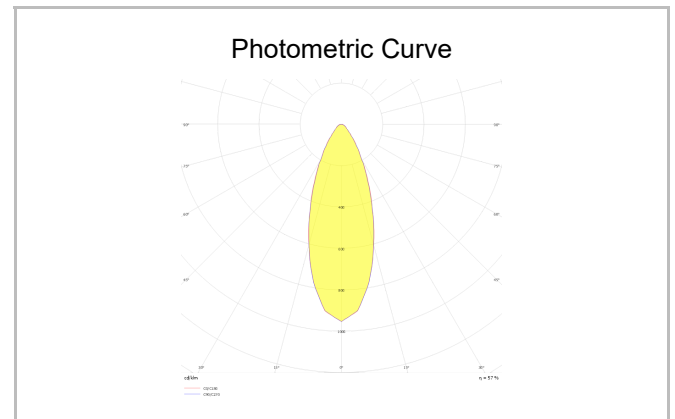
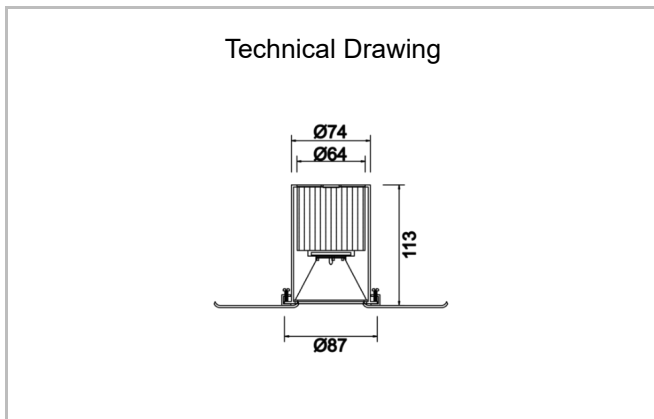

SKU	Product Code	Power (W)	Luminous Flux (LM)	CRI	CCT (K)	Optics	Dimensions (mm)
	LPY 008 011 009B 8040 10 30 SD 20 00	9	810	>80	4000	30° Reflector	Ø87x113

[www.atellighting.com](http://www.atellighting.com)