

Motus S

MTS 008 008 007A 8040 10 15 SD 20 00



Recessed Downlight & Spot Luminary



Luminaire Group	Downlight & Spot
Mounting Type	Recessed
Luminaire Color	RAL 9005 - RAL 9016 - RAL 9006
Housing	Aluminum Injection
Optics	15° 30° 40° Reflector & Opal Diffuser
Light Source	LED
Electrical Protection Class	CLASS II
IP	20
IK	02
Operating Temperature	-20°C / +40°C
Luminous Flux	630
Consumption Power	7
Luminaire Efficiency	90 lm/W
Color Rendering (CRI)	>80
Light Color Temperature (CCT)	2700K/3000K/4000K/6500K
Color Tolerance	< 3 SDCM
Driver Type	On/Off
Driver Brand	Tridonic
LED Brand	Samsung
Input Voltage / Frequency	220-240 V AC 50/60 Hz
Power Factor	>0.9
Surge	1kV
THD (AKIM)	>%20
LED life	>70.000 hours
Option	On-Off / Dali / 1-10V / With Emergency Kit

Technical Drawing

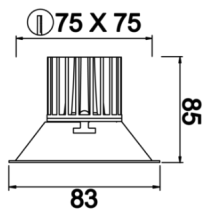

Photometric Curve

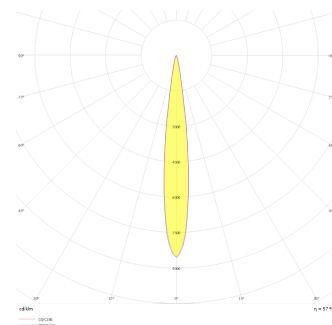

SKU	Product Code	Power (W)	Luminous Flux (LM)	CRI	CCT (K)	Optics	Dimensions (mm)
13502457	MTS 008 008 007A 8040 10 15 SD 20 00	7	630	>80	4000	15° Reflector	83x83xx85

www.atellighting.com