

# Motus M

MTS 010 008 009A 8040 10 30 SD 20 00



Recessed Downlight & Spot Luminary



|                                      |  |
|--------------------------------------|--|
| <b>Luminaire Group</b>               | Downlight & Spot                           |
| <b>Mounting Type</b>                 | Recessed                                   |
| <b>Luminaire Color</b>               | RAL 9005 - RAL 9016 - RAL 9006             |
| <b>Housing</b>                       | Aluminum Injection                         |
| <b>Optics</b>                        | 15° 30° 40° Reflector & Opal Diffuser      |
| <b>Light Source</b>                  | LED  |
| <b>Electrical Protection Class</b>   | CLASS II                                   |
| <b>IP</b>                            | 20   |
| <b>IK</b>                            | 02   |
| <b>Operating Temperature</b>         | -20°C / +40°C                              |
| <b>Luminous Flux</b>                 | 810  |
| <b>Consumption Power</b>             | 9  |
| <b>Luminaire Efficiency</b>          | 90 lm/W                                    |
| <b>Color Rendering (CRI)</b>         | >80  |
| <b>Light Color Temperature (CCT)</b> | 2700K/3000K/4000K/6500K                    |
| <b>Color Tolerance</b>               | < 3 SDCM                                   |
| <b>Driver Type</b>                   | On/Off                                     |
| <b>Driver Brand</b>                  | Tridonic                                   |
| <b>LED Brand</b>                     | Samsung                                    |
| <b>Input Voltage / Frequency</b>     | 220-240 V AC 50/60 Hz                      |
| <b>Power Factor</b>                  | >0.9                                       |
| <b>Surge</b>                         | 1kV  |
| <b>THD (AKIM)</b>                    | >%20                                       |
| <b>LED life</b>                      | >70.000 hours                              |
| <b>Option</b>                        | On-Off / Dali / 1-10V / With Emergency Kit |

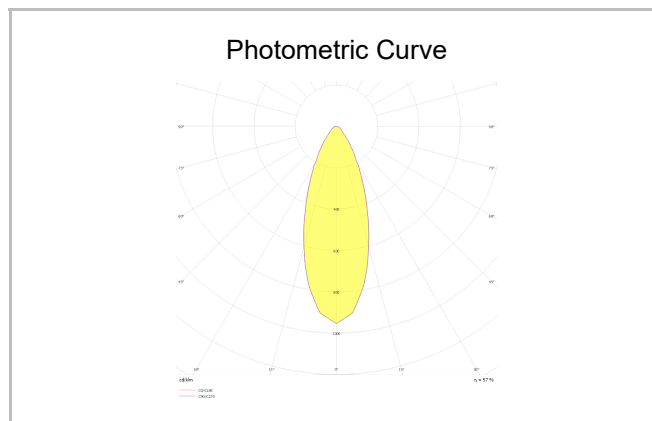
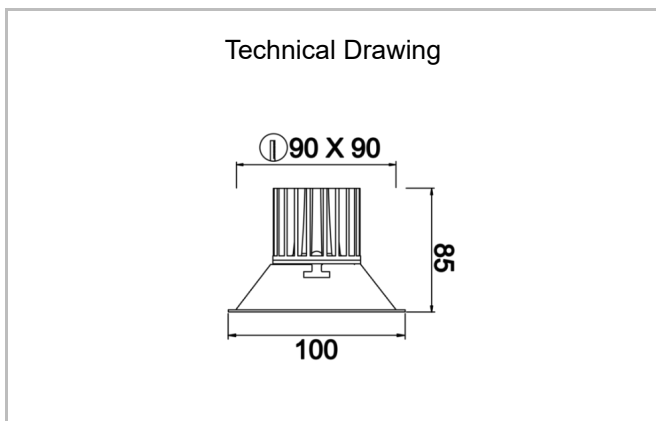

| SKU      | Product Code                         | Power (W) | Luminous Flux (LM) | CRI | CCT (K) | Optics        | Dimensions (mm) |
|----------|--------------------------------------|-----------|--------------------|-----|---------|---------------|-----------------|
| 13502691 | MTS 010 008 009A 8040 10 30 SD 20 00 | 9         | 810                | >80 | 4000    | 30° Reflector | 100x100x85      |