

Oblong Mini I

OBL 008 007 009A 8040 10 15 SD 40 00



Recessed Downlight & Spot Luminary



| | |
|--------------------------------------|--|
| Luminaire Group | Downlight & Spot |
| Mounting Type | Recessed |
| Luminaire Color | RAL 9005 - RAL 9006 - RAL 9010 |
| Housing | DKP Sheet |
| Optics | 15° 30° 40° Reflector & Opal Diffuser |
| Light Source | LED |
| Electrical Protection Class | CLASS II |
| IP | 40 |
| IK | 02 |
| Operating Temperature | -20°C / +40°C |
| Luminous Flux | 810 |
| Consumption Power | 9 |
| Luminaire Efficiency | 90 lm/W |
| Color Rendering (CRI) | >80 |
| Light Color Temperature (CCT) | 2700K/3000K/4000K/6500K |
| Color Tolerance | < 3 SDCM |
| Driver Type | On/Off |
| Driver Brand | Tridonic |
| LED Brand | Samsung |
| Input Voltage / Frequency | 220-240 V AC 50/60 Hz |
| Power Factor | >0.9 |
| Surge | 1kV |
| THD (AKIM) | >%20 |
| LED life | >70.000 hours |
| Option | On-Off / Dali / 1-10V / With Emergency Kit |

Technical Drawing

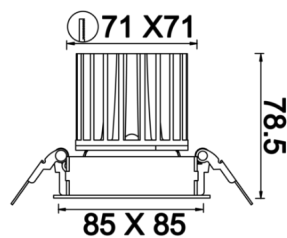

Photometric Curve

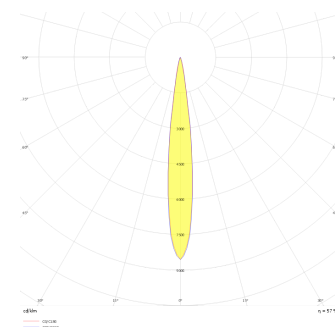

| SKU | Product Code | Power (W) | Luminous Flux (LM) | CRI | CCT (K) | Optics | Dimensions (mm) |
|-----|--------------------------------------|-----------|--------------------|-----|---------|---------------|-----------------|
| | OBL 008 007 009A 8040 10 15 SD 40 00 | 9 | 810 | >80 | 4000 | 15° Reflector | 85x85x78,5 |

www.atelighting.com