

Oblong Mini I

OBL 008 007 009A 8040 10 30 SD 40 00



Recessed Downlight & Spot Luminary



Luminaire Group	Downlight & Spot
Mounting Type	Recessed
Luminaire Color	RAL 9005 - RAL 9006 - RAL 9010
Housing	DKP Sheet
Optics	15° 30° 40° Reflector & Opal Diffuser
Light Source	LED
Electrical Protection Class	CLASS II
IP	40
IK	02
Operating Temperature	-20°C / +40°C
Luminous Flux	810
Consumption Power	9
Luminaire Efficiency	90 lm/W
Color Rendering (CRI)	>80
Light Color Temperature (CCT)	2700K/3000K/4000K/6500K
Color Tolerance	< 3 SDCM
Driver Type	On/Off
Driver Brand	Tridonic
LED Brand	Samsung
Input Voltage / Frequency	220-240 V AC 50/60 Hz
Power Factor	>0.9
Surge	1kV
THD (AKIM)	>%20
LED life	>70.000 hours
Option	On-Off / Dali / 1-10V / With Emergency Kit

Technical Drawing

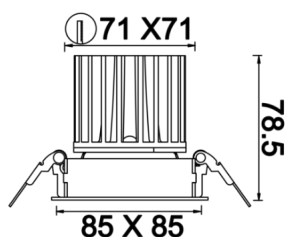

Photometric Curve

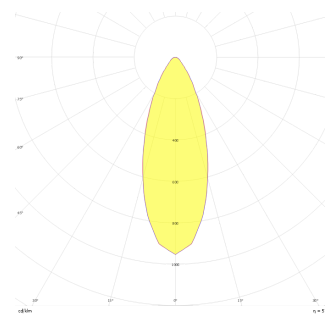

SKU	Product Code	Power (W)	Luminous Flux (LM)	CRI	CCT (K)	Optics	Dimensions (mm)
	OBL 008 007 009A 8040 10 30 SD 40 00	9	810	>80	4000	30° Reflector	85x85x78,5

www.atellighting.com