

Dif S

DIF 008 018 007S 8040 10 30 SD 65 00



Surface Mounted Surface Mounted Luminary



Luminaire Group	Surface Mounted
Mounting Type	Surface Mounted
Luminaire Color	RAL 9006 - RAL 9005 - RAL 9010 - RAL 9016
Housing	Aluminum Extrusion
Optics	15° 30° 40° Reflector & Transparent Diffuser
Light Source	LED
Electrical Protection Class	CLASS II
IP	65
IK	03
Operating Temperature	-20°C / +40°C
Luminous Flux	677
Consumption Power	7
Luminaire Efficiency	91 lm/W
Color Rendering (CRI)	>80
Light Color Temperature (CCT)	2700K/3000K/4000K/6500K
Color Tolerance	< 3 SDCM
Driver Type	On/Off
Driver Brand	Tridonic
LED Brand	Samsung
Input Voltage / Frequency	220-240 V AC 50/60 Hz
Power Factor	>0.9
Surge	1kV
THD (AKIM)	>%20
LED life	>100.000 hours
Option	On-Off / Dali / 1-10V / With Emergency Kit

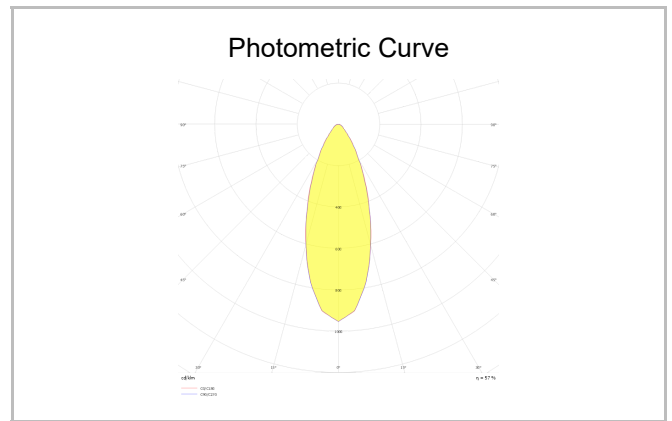
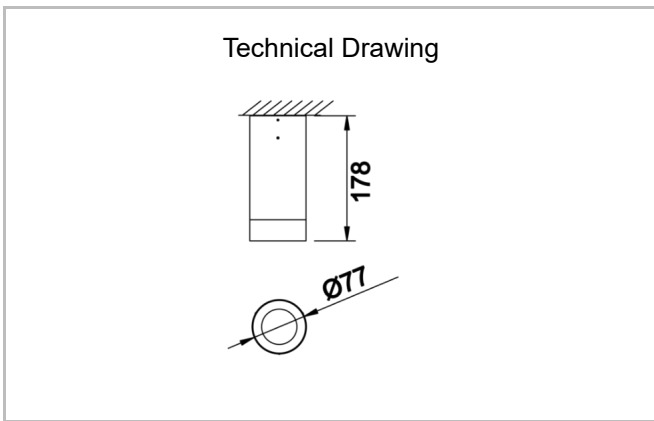

SKU	Product Code	Power (W)	Luminous Flux (LM)	CRI	CCT (K)	Optics	Dimensions (mm)
	DIF 008 018 007S 8040 10 30 SD 65 00	7	677	>80	4000	30° Reflector	Ø77x178