

Dif M

DIF 010 020 009S 8040 10 40 SD 65 00



Surface Mounted Surface Mounted Luminaire



Luminaire Group	Surface Mounted
Mounting Type	Surface Mounted
Luminaire Color	RAL 9006 - RAL 9005 - RAL 9010 - RAL 9016
Housing	Aluminum Extrusion
Optics	15° 30° 40° Reflector & Transparent Diffuser
Light Source	LED
Electrical Protection Class	CLASS II
IP	65
IK	03
Operating Temperature	-20°C / +40°C
Luminous Flux	819
Consumption Power	9
Luminaire Efficiency	91 lm/W
Color Rendering (CRI)	>80
Light Color Temperature (CCT)	2700K/3000K/4000K/6500K
Color Tolerance	< 3 SDCM
Driver Type	On/Off
Driver Brand	Tridonic
LED Brand	Samsung
Input Voltage / Frequency	220-240 V AC 50/60 Hz
Power Factor	>0.9
Surge	1kV
THD (AKIM)	>%20
LED life	>100.000 hours
Option	On-Off / Dali / 1-10V / With Emergency Kit

Technical Drawing

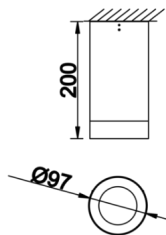

Photometric Curve

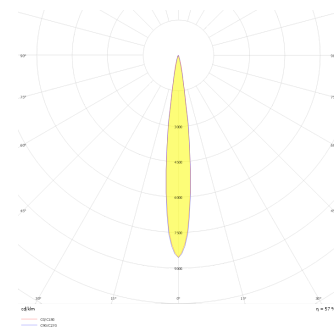

Dif M

DIF 010 020 009S 8040 10 40 SD 65 00



Surface Mounted Surface Mounted Luminary

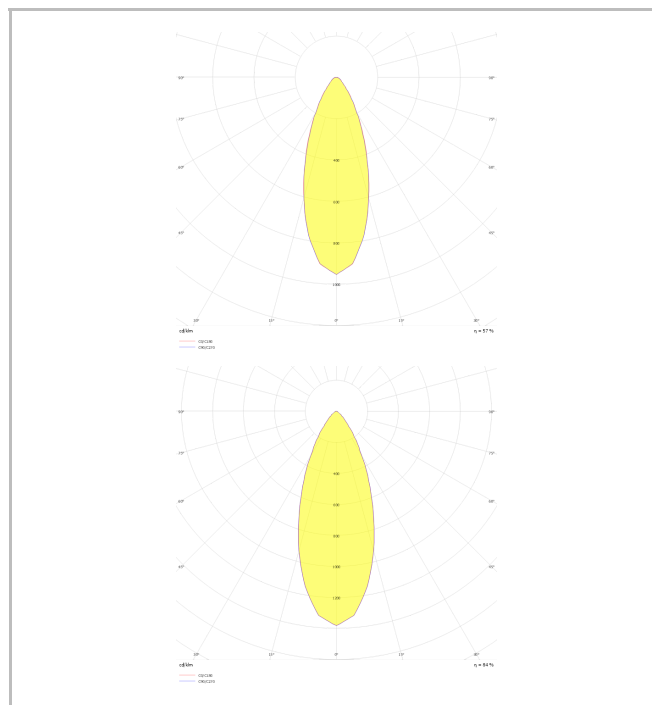
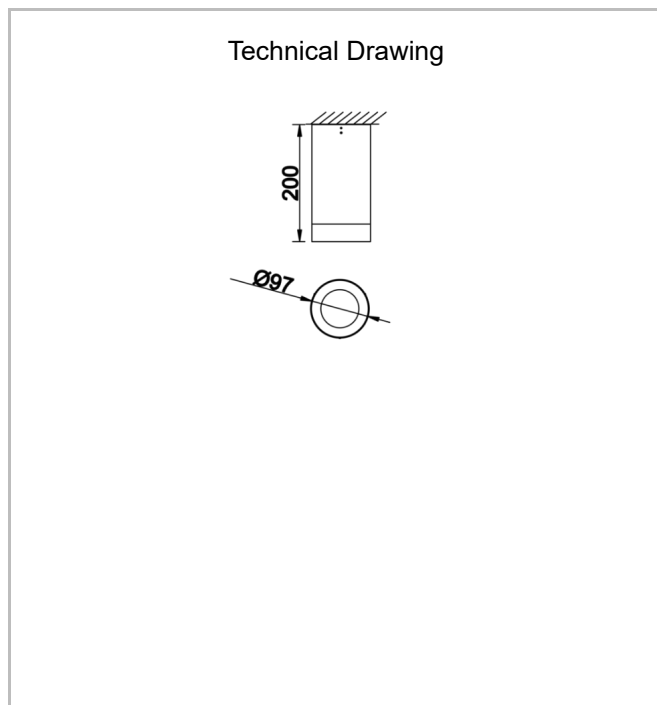

SKU	Product Code	Power (W)	Luminous Flux (LM)	CRI	CCT (K)	Optics	Dimensions (mm)
	DIF 010 020 009S 8040 10 40 SD 65 00	9	819	>80	4000	40° Reflector	Ø97x200