

# Dif S

DIF 008 018 009S 8040 10 40 SD 65 00



Surface Mounted Surface Mounted Luminary



<b>Luminaire Group</b>	Surface Mounted
<b>Mounting Type</b>	Surface Mounted
<b>Luminaire Color</b>	RAL 9006 - RAL 9005 - RAL 9010 - RAL 9016
<b>Housing</b>	Aluminum Extrusion
<b>Optics</b>	15° 30° 40° Reflector & Transparent Diffuser
<b>Light Source</b>	LED
<b>Electrical Protection Class</b>	CLASS II
<b>IP</b>	65
<b>IK</b>	03
<b>Operating Temperature</b>	-20°C / +40°C
<b>Luminous Flux</b>	819
<b>Consumption Power</b>	9
<b>Luminaire Efficiency</b>	91 lm/W
<b>Color Rendering (CRI)</b>	>80
<b>Light Color Temperature (CCT)</b>	2700K/3000K/4000K/6500K
<b>Color Tolerance</b>	< 3 SDCM
<b>Driver Type</b>	On/Off
<b>Driver Brand</b>	Tridonic
<b>LED Brand</b>	Samsung
<b>Input Voltage / Frequency</b>	220-240 V AC 50/60 Hz
<b>Power Factor</b>	>0.9
<b>Surge</b>	1kV
<b>THD (AKIM)</b>	>%20
<b>LED life</b>	>100.000 hours
<b>Option</b>	On-Off / Dali / 1-10V / With Emergency Kit

Technical Drawing

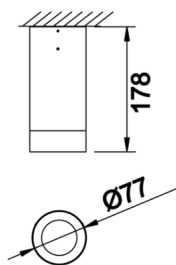

Photometric Curve

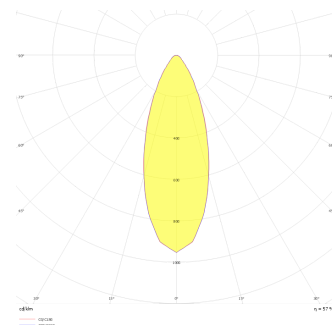

SKU	Product Code	Power (W)	Luminous Flux (LM)	CRI	CCT (K)	Optics	Dimensions (mm)
	DIF 008 018 009S 8040 10 40 SD 65 00	9	819	>80	4000	40° Reflector	Ø77x178

[www.atellighting.com](http://www.atellighting.com)