

# Dimple Drums Pendant

DDR 060 025 035P 9040 10 99 OP 40 00



Pendant Pendant Luminary



<b>Luminaire Group</b>	Pendant
<b>Mounting Type</b>	Pendant
<b>Luminary Color</b>	RAL 9005 - RAL 9006 - RAL 9010
<b>Housing</b>	Dkp Sheet
<b>Optics</b>	Opal Diffuser
<b>Light Source</b>	LED
<b>Electrical Protection Class</b>	CLASS II
<b>IP</b>	40
<b>IK</b>	02
<b>Operating Temperature</b>	-20°C / +40°C
<b>Luminous Flux</b>	4730
<b>Consumption Power</b>	35
<b>Luminaire Efficiency</b>	108 lm/W
<b>Color Rendering (CRI)</b>	>80
<b>Light Color Temperature (CCT)</b>	2700K/3000K/4000K/6500K
<b>Color Tolerance</b>	< 3 SDCM
<b>Driver Type</b>	On/Off
<b>Driver Brand</b>	Tridonic
<b>LED Brand</b>	Samsung
<b>Input Voltage / Frequency</b>	220-240 V AC 50/60 Hz
<b>Power Factor</b>	>0.9
<b>Surge</b>	1kV
<b>THD (AKIM)</b>	>%20
<b>LED life</b>	>70.000 hours
<b>Option</b>	On-Off / Dali / 1-10V / With Emergency Kit

Technical Drawing

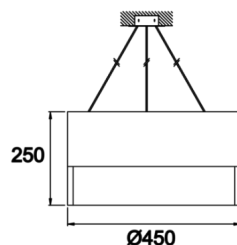
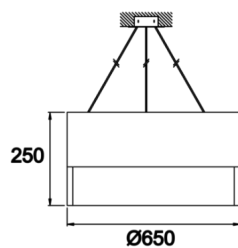

Photometric Curve

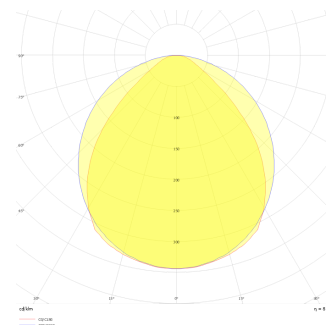

[www.atellighting.com](http://www.atellighting.com)

# Dimple Drums Pendant

DDR 060 025 035P 9040 10 99 OP 40 00



Pendant Pendant Luminary

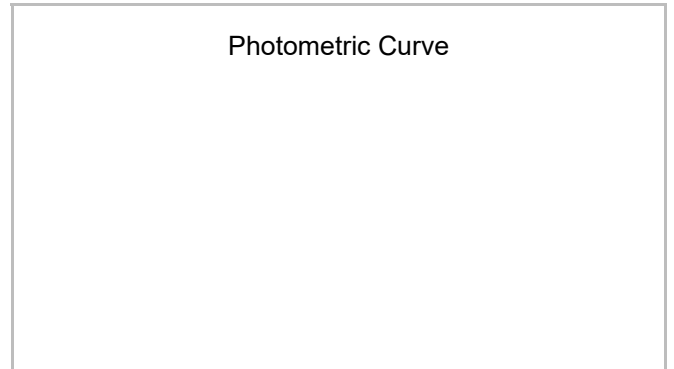
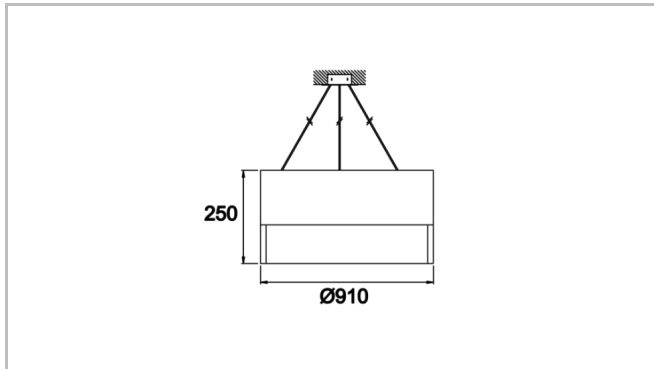

SKU	Product Code	Power (W)	Luminous Flux (LM)	CRI	CCT (K)	Optics	Dimensions (mm)
	DDR 060 025 035P 9040 10 99 OP 40 00	35	4730	>80	4000	120° Diffuser	Ø600x250