

# Shackle

SHA 013 015 018W 8040 10 30 CA 20 00



Track Lighting Luminary



<b>Luminaire Group</b>	Track Lighting
<b>Luminary Color</b>	RAL 9005 - RAL 9006 - RAL 9010
<b>Housing</b>	Aluminum
<b>Optics</b>	19° 30° 55° Reflector and Diffuser
<b>Light Source</b>	LED
<b>Electrical Protection Class</b>	CLASS II
<b>IP</b>	20
<b>IK</b>	02
<b>Operating Temperature</b>	-20°C / +40°C
<b>Luminous Flux</b>	1440
<b>Consumption Power</b>	18
<b>Luminaire Efficiency</b>	80 lm/W
<b>Color Rendering (CRI)</b>	>80
<b>Light Color Temperature (CCT)</b>	2700K/3000K/4000K/6500K
<b>Color Tolerance</b>	< 3 SDCM
<b>Driver Type</b>	On/Off
<b>Driver Brand</b>	Tridonic
<b>LED Brand</b>	Samsung
<b>Input Voltage / Frequency</b>	220-240 V AC 50/60 Hz
<b>Power Factor</b>	>0.9
<b>Surge</b>	1kV
<b>THD (AKIM)</b>	>%20
<b>LED life</b>	>70.000 hours
<b>Option</b>	On-Off / Dali / 1-10V

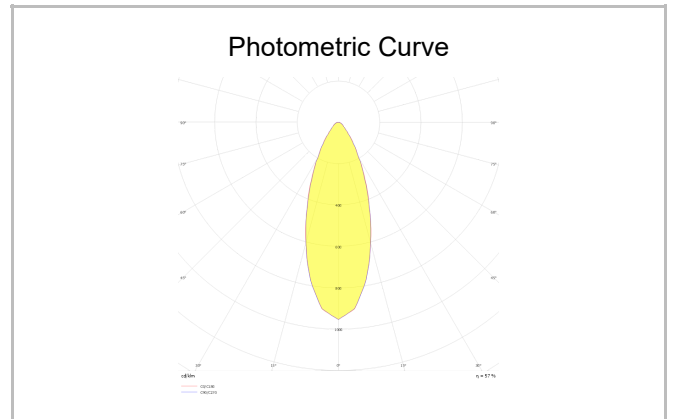
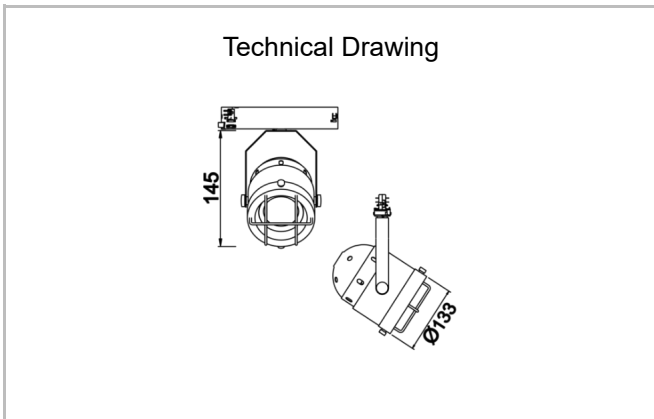

SKU	Product Code	Power (W)	Luminous Flux (LM)	CRI	CCT (K)	Optics	Dimensions (mm)
	SHA 013 015 018W 8040 10 30 CA 20 00	18	1440	>80	4000	30° Reflector	Ø133x145

[www.atellighting.com](http://www.atellighting.com)