

Oculus S & M

OCU 016 010 009Z 8030 10 90 LN 65 00



In-Floor Recessed Facade & Landscape Luminaire



| | |
|--------------------------------------|---|
| Luminaire Group | Facade & Landscape |
| Mounting Type | In-Floor Recessed |
| Luminaire Color | RAL 9005 - RAL 9006 - RAL 9010 |
| Housing | Aluminum Body Stainless Steel Frame Tempered Glass |
| Optics | 15° 40° 90° Lens |
| Light Source | LED |
| Electrical Protection Class | CLASS II |
| IP | 65 |
| IK | 09 |
| Operating Temperature | -20°C / +40°C |
| Luminous Flux | 1080 |
| Consumption Power | 9 |
| Luminaire Efficiency | 120 lm/W |
| Color Rendering (CRI) | >80 |
| Light Color Temperature (CCT) | 2700K/3000K/4000K/6500K |
| Color Tolerance | < 3 SDCM |
| Driver Type | On/Off |
| Driver Brand | Tridonic |
| LED Brand | Samsung |
| Input Voltage / Frequency | 220-240 V AC 50/60 Hz |
| Power Factor | >0.9 |
| Surge | 1kV |
| THD (AKIM) | >%20 |
| LED life | >70.000 hours |
| Option | On-Off / Dali / 1-10V / With Emergency Kit |

Technical Drawing

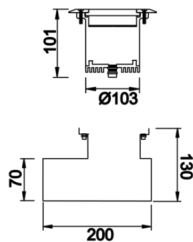

Oculus S & M

OCU 016 010 009Z 8030 10 90 LN 65 00



In-Floor Recessed Facade & Landscape Luminary

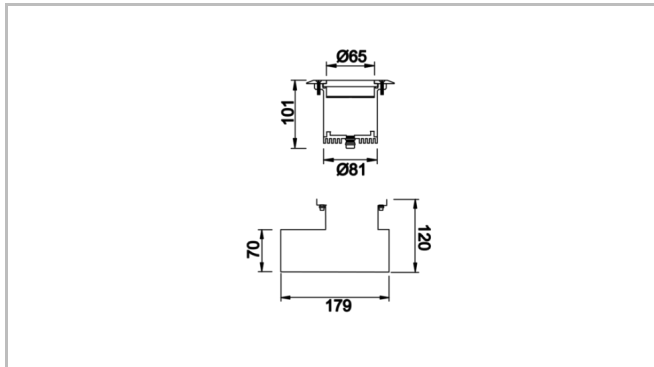

| SKU | Product Code | Power (W) | Luminous Flux (LM) | CRI | CCT (K) | Optics | Dimensions (mm) |
|----------|--------------------------------------|-----------|--------------------|-----|---------|----------|-----------------|
| 72000125 | OCU 016 010 009Z 8030 10 90 LN 65 00 | 9 | 1080 | >80 | 4000 | 90° Lens | Ø103x101 |