

Roadster-M

ROA 018 051 100M 8040 10 SM CM 66 00



Road Lighting & Floodlight Luminary



Luminaire Group	Road Lighting & Floodlight
Luminary Color	RAL 9005
Housing	Aluminum Injection
Optics	Symmetrical / Asymmetrical° Lens & Tempered Glass
Light Source	LED
Electrical Protection Class	CLASS II
IP	66
IK	08
Operating Temperature	-40°C / +40°C
Luminous Flux	12500
Consumption Power	100
Luminaire Efficiency	125 lm/W
Color Rendering (CRI)	>70
Light Color Temperature (CCT)	3000K/4000K/6500K
Color Tolerance	< 3 SDCM
Driver Type	On/Off
Input Voltage / Frequency	220-240 V AC 50/60 Hz
Power Factor	>0.9
Surge	1kV
THD (AKIM)	>%20
LED life	>100.000 hours

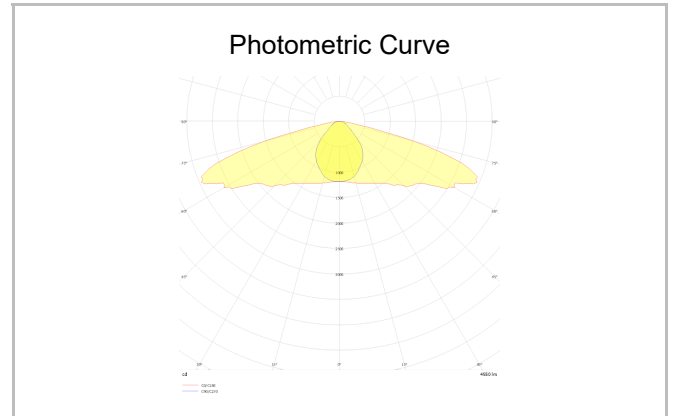
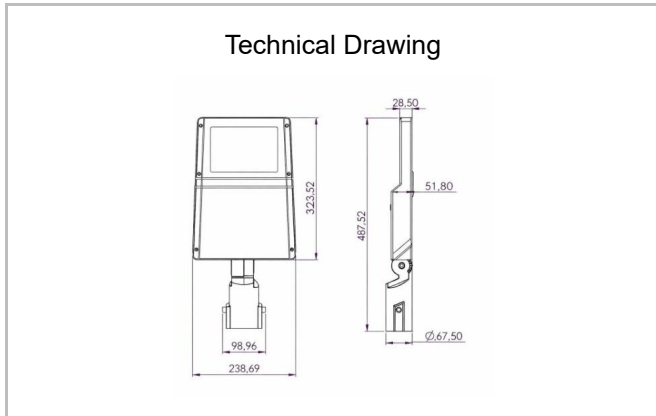

SKU	Product Code	Power (W)	Luminous Flux (LM)	CRI	CCT (K)	Optics	Dimensions (mm)
	ROA 018 051 100M 8040 10 SM CM 66 00	100	12500	>70	4000	Symmetrical Lens	182x516x76 mm