

Promete M

PRO 042 038 200Y 8040 10 AS LN 66 00



Road Lighting & Floodlight Luminary



Luminaire Group	Road Lighting & Floodlight
Luminary Color	RAL 9005
Housing	Aluminum Injection Electrostatic Powder Coated
Optics	Symmetrical / Asymmetrical° Lens & Tempered Glass
Light Source	LED
Electrical Protection Class	CLASS II
IP	66
IK	08
Operating Temperature	-40°C / +55°C
Luminous Flux	24000
Consumption Power	200
Luminaire Efficiency	120 lm/W
Color Rendering (CRI)	>70
Light Color Temperature (CCT)	3000K/4000K/6500K
Color Tolerance	< 3 SDCM
Driver Type	On/Off
Input Voltage / Frequency	220-240 V AC 50/60 Hz
Power Factor	>0.9
Surge	1kV
THD (AKIM)	>%20
LED life	>100.000 hours

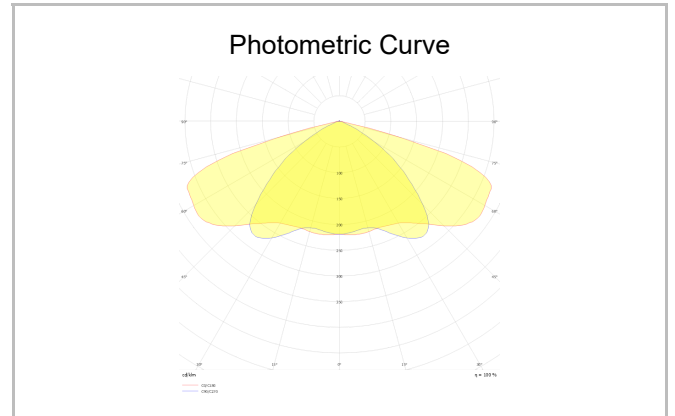
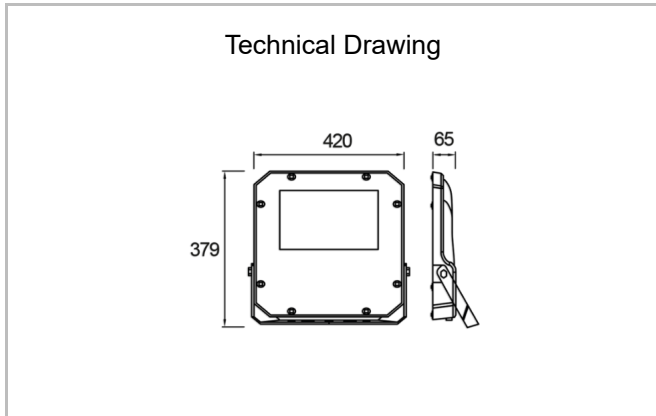

SKU	Product Code	Power (W)	Luminous Flux (LM)	CRI	CCT (K)	Optics	Dimensions (mm)
	PRO 042 038 200Y 8040 10 AS LN 66 00	200	24000	>70	4000	Asymmetric Lens	420x379x65