

# Drums

DRM 060 008 051S 8040 26 99 OP 40 00

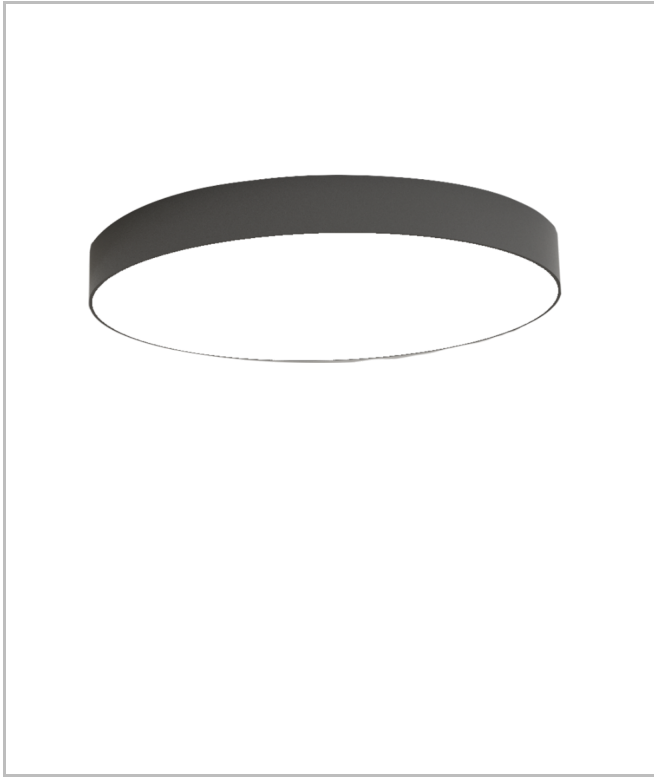

Surface Mounted Surface Mounted Luminary



<b>Luminaire Group</b>	Surface Mounted
<b>Mounting Type</b>	Surface Mounted
<b>Luminaire Color</b>	RAL 9005 - RAL 9006 - RAL 9010
<b>Housing</b>	Aluminum Extrusion
<b>Optics</b>	Opal Diffuser
<b>Light Source</b>	LED
<b>Electrical Protection Class</b>	CLASS II
<b>IP</b>	40
<b>IK</b>	02
<b>Operating Temperature</b>	-20°C / +40°C
<b>Luminous Flux</b>	6195
<b>Consumption Power</b>	51
<b>Luminaire Efficiency</b>	124,5 lm/W
<b>Color Rendering (CRI)</b>	>80
<b>Light Color Temperature (CCT)</b>	2700K/3000K/4000K/6500K
<b>Color Tolerance</b>	< 3 SDCM
<b>Driver Type</b>	On/Off
<b>Driver Brand</b>	Tridonic
<b>LED Brand</b>	Samsung
<b>Input Voltage / Frequency</b>	220-240 V AC 50/60 Hz
<b>Power Factor</b>	>0.9
<b>Surge</b>	1kV
<b>THD (AKIM)</b>	>%20
<b>LED life</b>	>50.000 hours
<b>Option</b>	On-Off / Dali / 1-10V / With Emergency Kit

Technical Drawing

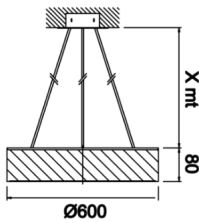

Photometric Curve

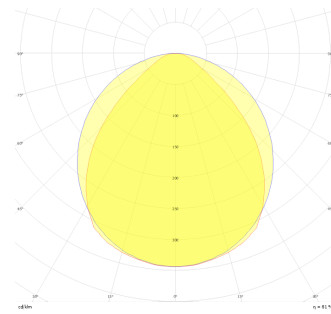

SKU	Product Code	Power (W)	Luminous Flux (LM)	CRI	CCT (K)	Optics	Dimensions (mm)
	DRM 060 008 051S 8040 26 99 OP 40 00	51	6195	>80	4000	120° Opal Diffuser	Ø60